

# AQUATICA SPA MANUAL

OPERATIONS AND MAINTENANCE

## **INTRODUCTION**

Thank you for choosing your Aquatica Spa. This manual is your go-to guide for making the most of your new outdoor oasis.

Aquatica Spas are crafted to provide an incredible experience of relaxation and rejuvenation. Whether you are looking for a peaceful escape or a lively gathering spot, your spa is designed to enhance your well-being and lifestyle.

We are dedicated to making sure your experience is fantastic. Please take a moment to read this manual before installation and use it to enjoy your spa safely and effortlessly.

*At the time of creation, the information within this manual is accurate, Aquatica reserves the right to change or improve its product without prior notice.*

## Contents

1. Health and Safety Instruction .....	4
2. Spa Models.....	6
3. Installation Guidance.....	8
3.1. Site Selection and Preparation .....	8
3.2. Pre-Installation Testing .....	10
3.3. Electrical Guidance .....	11
3.4. Plumbing Guidance .....	13
3.5. Spa Filling Guidance .....	13
4. Operating Instructions.....	15
4.1. Control panel – Balboa Spa Touch 3 Keypad .....	15
4.2. Control panel – Balboa Spa Touch 4 Keypad .....	23
4.3. Control panel – Gecko in.k1000 Keypad.....	28
4.4. Auto Fill and Drain (Optional Extra).....	30
4.5. Pneumatic Elevator for Built in Spas (Optional Extra).....	31
4.6. Bluetooth Audio (Optional Extra) .....	32
4.7. Second Heater (Optional Extra) .....	32
4.8. Auxiliary Heater/Chiller (Optional Extra) .....	33
4.9. Aromatherapy (Optional Extra) .....	33
4.10. Active Hydromassage (Optional Extra).....	34
5. Maintaining your Spa.....	35
5.1. Protecting your Spa.....	35
5.2. Spa Cleaning .....	35
5.3. Water Quality .....	36
5.4. Cleaning and Replacing Water Filters.....	39
5.5. Winterization.....	41
5.6. Accessory care.....	42
6. Troubleshooting.....	43
7. Useful Information .....	46

# 1. Health and Safety Instruction

## **IMPORTANT HEALTH AND SAFETY INSTRUCTIONS, READ AND FOLLOW ALL INSTRUCTIONS**

### **DANGER: RISK OF SEVERE INJURY OR DROWNING**

- Take extreme caution to prevent unauthorized and unsupervised access to this spa, especially by children, the spa should be supervised at all times during usage.
- Take extra precautions by securing a spa cover when not in use.

### **WARNING: RISK OF SEVERE INJURY OR DEATH**

- Extreme caution must be exercised to prevent diving or jumping into the spa or slipping and falling, which could result in unconsciousness, drowning, or serious injury.
- The surface around the spa may become very slippery, be careful when entering or exiting the water.
- Observe a reasonable time limit when using the spa, prolonged time in a spa may cause injury to your health.
- High water temperatures can cause high body temperatures (overheating). Symptoms may include fainting, dizziness, drowsiness, nausea, and reduced awareness. These symptoms could possibly result in drowning or serious injury.
- Never use a spa immediately following strenuous exercise.

### **DANGER: RISK OF SEVERE INJURY OR DEATH FROM ELECTRIC SHOCK**

- Do not install the spa less than 1.5m away from any metal surfaces.
- As an alternative, a spa may be installed within 1.5m of metal surfaces if each metal surface is permanently bonded by a minimum of 8.0 mm<sup>2</sup> solid copper conductor attached to the wire connector on the grounding lug.
- Consider local electrical standards that prohibit any electrical installation (plug sockets, switches, lamps, etc.) in the area surrounding the Spa.
- Industry standards do not permit electrical appliances such as light, telephone, radio, television, etc. to be within 1.5m of a spa unless such appliances are built-in by the manufacturer.
- Never bring or operate any electrical appliances in or near the spa, or when wet.
- The installation must have one residual-current circuit breaker with overcurrent protection (RCBO) or Residual Current Device (RCD).
- The RCBO/RCD protects against line shock hazard. Depending on the spa specifications, the use of either a 208-240V, 40A, 50A or 60A, 50Hz dedicated service to wire the control system.

### **DECREASE THE RISK OF INFECTION, DISEASE OR PRODUCT DAMAGE**

- Maintain water chemistry in accordance with manufacturer's instructions.
- Always maintain the water chemistry within the recommended parameters to reduce the risk of contracting waterborne illness (e.g. bacteria, infection or virus) and/or respiratory ailments.
- Always shower before and after using your spa.
- Proper chemical maintenance of the spa's water is necessary to maintain safe water and prevent possible damage to the spa components.
- **WARNING:** In addition to maintenance of the filters and water chemistry, proper ventilation is recommended to reduce the risk of contaminating the water with waterborne illnesses and/or respiratory ailments that could be present in the air or water. Consult a licensed contractor to determine your specific needs if installing your Spa indoors.

### **IMPORTANT ADDITIONAL INSTRUCTIONS**

- An equipment bonding terminal is provided in the field wiring compartment. To reduce the risk of electric shock, this terminal must be connected to the bonding means provided in the electric supply panel with a conductor equivalent in size to the circuit conductors supplying this equipment.

- Provide unrestricted service access to the pump, blower, in-line heater, adjustable feet, and for built-in models you must construct an access panel or service lift to provide sufficient clearance for servicing. The access panel must be located immediately next to the pumps and heater.
- **IMPORTANT:** Because of the combined weight of the spa, water and users, it is extremely important that the base upon which the spa rests be smooth, flat, level and capable of uniformly supporting this weight, without shifting or settling, for the entire time the spa is in place.
- **WARNING:** For spas that are to rest on balconies, roofs or other platforms not specifically tied to main structural support, consult a professional Structural Engineer with experience in this type of application.
- Proper drainage is required. The installation must not allow the spa equipment bay to become flooded. It is your responsibility, and the responsibility of any installation contractor you hire, to make sure that all applicable codes and/or local construction requirements are met. If in doubt, refer to the building authority responsible for approving the proposed installation site.

## 2. Spa Models

### SPA DIMENSIONS, WEIGHTS AND AMPS

Aquatica Spa Models	Dimensions L x W x H (mm)	Empty Weight kg	Filled Weight kg *	Capacity in Liters	Amps Required **	Recommended Breaker (amps) ***	Copper Cable Size mm2 ***
Downtown	2000 x 1500 x 800 mm	220	940	720	37.2A	50	16
Downtown with DurateX Cabinet	2340 x 1840 x 800 mm	250	970	720	37.2A	50	16
Downtown Infinity	2500 x 2000 x 820 mm	310	1250	940	39.5A	50	16
Downtown 2	2000 x 2000 x 820 mm	275	1355	1080	45A	60	25
Vibe	2400 x 1950 x 850 mm	300	1460	1160	37A	50	16
Vibe Infinity	2800 x 2350 x 860 mm	430	2090	1660	42A	60	25





\*Filled weights are approximate and will vary to the point at which the spa is filled.

\*\*Exact Amp consumption will be based on the configuration of your purchase.

\*\*\*Recommended breaker and cable size to cover some added modifications.

**IMPORTANT** It's recommended that a second dedicated 240-volt power line, with 20Amp breaker be fitted to power the additional heater which draws 3,6kw / 16A, if this modification is purchased.

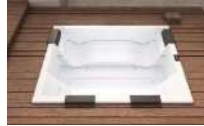
### SPA MODEL PRODUCT MODIFICATIONS

	DOWNTOWN	DOWNTOWN INFINITY	DOWNTOWN 2	VIBE	VIBE INFINIITY
					
<b>Built-In</b>	OPTIONAL	OPTIONAL	OPTIONAL	OPTIONAL	OPTIONAL
<b>Composite panels</b>	OPTIONAL	OPTIONAL	OPTIONAL	OPTIONAL	OPTIONAL
<b>Wooden Sides</b>	OPTIONAL	OPTIONAL	OPTIONAL	OPTIONAL	OPTIONAL
<b>DurateX Cabinet</b>	OPTIONAL	NOT AVAILABLE	NOT AVAILABLE	NOT AVAILABLE	NOT AVAILABLE
<b>Headrests</b>	INCLUDED AS STANDARD	INCLUDED AS STANDARD	INCLUDED AS STANDARD	OPTIONAL	OPTIONAL
<b>Cover</b>	OPTIONAL	OPTIONAL	OPTIONAL	OPTIONAL	OPTIONAL
<b>BT Audio</b>	OPTIONAL	OPTIONAL	OPTIONAL	OPTIONAL	OPTIONAL
<b>Auto Fill and Drain</b>	OPTIONAL	INCLUDED AS STANDARD	OPTIONAL	OPTIONAL	INCLUDED AS STANDARD
<b>Second heater</b>	OPTIONAL	OPTIONAL	OPTIONAL	OPTIONAL	OPTIONAL
<b>Aromatherapy</b>	OPTIONAL	OPTIONAL	OPTIONAL	OPTIONAL	OPTIONAL
<b>Active hydromassage</b>	NOT AVAILABLE	NOT AVAILABLE	NOT AVAILABLE	OPTIONAL	OPTIONAL
<b>Auxiliary Water Chiller Heater</b>	OPTIONAL	OPTIONAL	OPTIONAL	OPTIONAL	OPTIONAL
<b>Pneumatic Spa Lift</b>	OPTIONAL (Built-In Models Only)	OPTIONAL (Built-In Models Only)	OPTIONAL (Built-In Models Only)	OPTIONAL (Built-In Models Only)	OPTIONAL (Built-In Models Only)

## **SPA DRAWINGS**

Drawings of standard spas can be found on the Aquatica website

<https://www.aquaticabath.eu/installations> , and search your spa model. This includes drawings of inground models with Pneumatic Elevator product modification.

## 3. Installation Guidance

### IMPORTANT INFORMATION

Please read this information carefully. It provides guidelines on preparing for the delivery and setup of your Aquatica Spa, covering delivery access, site selection, ground preparation, and electrical and water requirements.

You may need permits or meet other obligations for installing electrical circuits or constructing exterior surfaces (like concrete pads, decks, or gazebos). Please consult your local authorities about specific requirements.

**IMPORTANT:** Your spa must be protected from direct sunlight when not filled or in use to prevent damage to the gelcoat. We strongly recommend using a suitable spa cover. Additionally, consider using an awning or umbrella for added protection from sunlight.

To ensure safety, do not place your spa within 10 feet (3 meters) of any overhead power lines or electrical fixtures.

### Delivery and Access Requirements

Before the delivery date, please ensure there is sufficient access and clearance for moving and positioning your spa. Aquatica spas are delivered curbside only, so you are responsible for arranging a suitable handling service for the final placement. Keep in mind the following:

- If the spa needs to be moved up or down an incline or a short flight of stairs, additional overhead clearance may be required.
- You may need to remove gates, parts of fences, or other movable obstructions to access the installation site.
- Having additional people on-site can help overcome small obstacles, but arranging this is your responsibility.
- In some cases, using a hi-ab or crane may be necessary to lift the spa to its destination.

We recommend planning a clear delivery route in advance to avoid any unexpected issues on the day of delivery or installation.

### 3.1. Site Selection and Preparation

**IMPORTANT:** The site selection and preparation are the customer's responsibility. Please read these instructions carefully and consult us if you have any questions. If you have a spot in mind for your new spa, please ensure the following:

- Your spa must be placed on a structurally sound, level surface. A filled spa can be very heavy, so make sure the chosen location can support its weight. (Refer to the spa dimensions and weights table in Section 2.)
- Position the equipment compartment, which houses all electrical components, where water can easily drain away from it. Avoid allowing water into this area, as it can damage the electronics and potentially trip your circuit breaker or RCD. Ensure easy access to all circuit breakers and RCDs.
- Ensure that the entire front of the spa is accessible (removable panels provide access to the equipment) for periodic care and maintenance. It's advisable to allow access around the entire spa if possible.

### CHECK YOUR CLEARANCES

Check the width of doorways, passages and gates to make sure the spa can pass. Gates, fences and doors may need to be moved. Ensure that there is nothing protruding such as drainage pipes or sills that could obstruct access. Check to see if there are any low roofs or branches that could hinder the vertical clearance. If there are any corners on the path to your designated installation site, check to see that the spa will pass. Please allow enough distance around corners to move the spa. Check that there are no steep slopes, retaining walls or large number of stairs that could cause problems.



Under special circumstances, where there is no clear and easy route, a crane can be used to deliver your new spa. Please note that any arrangements or costs of a crane are the customer's responsibility. Please take into consideration the following points for access:

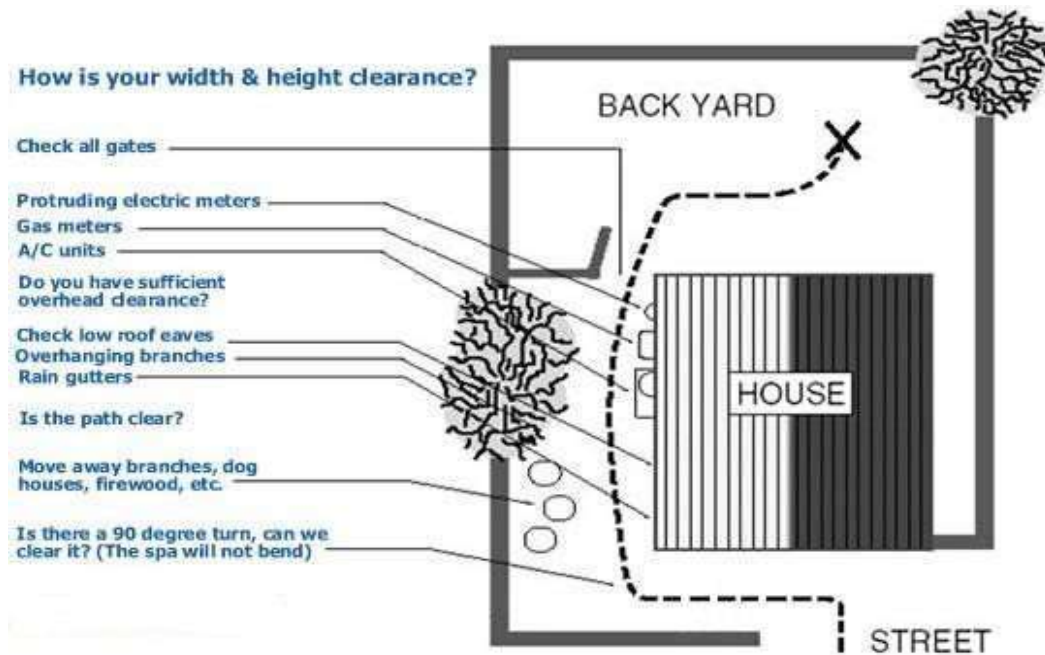

## SPA LOCATION PLANNING

### Outdoor

Regardless of where you install your new spa, it's important that you have a structurally sound, level and solid foundation to support it (grass is unsuitable). Structural damage due to incorrect installation or placement on an inadequate foundation is not covered under the spa's limited warranty.

For outdoor installations, we recommend a reinforced concrete pad at least 10cm thick. When selecting the ideal location for your spa, we suggest that you take into consideration:

- Choose a spot close to a changing area and shelter for convenience.
- Ensure the pathway to and from the spa is clear of debris, dirt, and leaves to prevent tracking into the spa.
- Position the spa away from trees and shrubs to minimize maintenance from leaves and bird droppings.
- A sheltered location can reduce wind and weather exposure, leading to lower operating and maintenance costs.
- Avoid placing the spa under an un-guttered roof overhang, as runoff water can shorten the spa's lifespan.

### Inground

When building a pit for in-ground installations, understanding the heights, where the finished surface ends in relation to the rim of the spa please consider the following.

- Service access crawl space of 60cm minimum.
- Drainage points in the base of the pit for ground, rain spa drain water.
- Removeable access panels.
- Spa configuration, Aquatica recommends the addition of electronic 'Fill 'n' Drain' for ease of water management.
- Consideration if a pneumatic spa lift is required, this reduces the size of the crawl space required.

### Deck

To be certain your deck can support your spa, you must know the deck's maximum load capacity.

- **IMPORTANT:** Before placing the spa on an elevated deck or indoors, consult a qualified building

contractor or structural engineer. It is crucial to ensure that the weight per square foot does not exceed the structure's rated capacity, as this could cause serious structural damage.

- Additionally, if you choose to sink the spa into decking, keep in mind that this will restrict access to the cabinet and the drainage point.

### Indoors

If you decide to place your spa indoors, please be aware of the following special requirements:

- Choose flooring materials that provide a good grip when wet, as water will accumulate around the tub.
- Spas should be drained approximately every 10 to 12 weeks, depending on usage. Ensure ease of drainage is considered, and it's recommended to install a floor drain when building the room.
- The installation will naturally increase humidity levels, which can lead to moisture damage, such as dry rot or mildew, in woodwork and other materials. Monitor exposed wood, paper, and similar items for moisture damage. To minimize these effects, ensure adequate ventilation in the spa area, and consider installing a dehumidifier if necessary.
- Make sure there is sufficient ceiling height for removing the spa cover and for your own height when entering and exiting the spa. Also, ensure that there is adequate space for installation and that your chosen model will fit comfortably in the room.

## ADDITIONAL ACCESS REQUIREMENTS

### Service Compartment

Service Technicians may require access to the equipment inside your spa, therefore, you need to plan the location of the spa to allow easy access (we recommend leaving a space of 60cm).

### Cover Lift

To make it easier to access your spa, you may decide to purchase a cover lifter from a 3rd party supplier which would enable a single person to uncover the spa. If you decide to invest in a cover lifter it is recommended to leave an additional 400mm on each side of your spa to be able to walk down the side and operate the cover lifter and then 600mm at the rear of your spa for the storage area of the cover and cover lifter.

### Steps

If you have decided to install spa steps, you will need to consider how much extra clearance you will need at the front of the spa.

### Pneumatic Spa Lift

For inground spa models, a pneumatic lift can be installed to raise the spa out of the ground for annual maintenance and periodic service, thus reducing the size of the crawl space needed in the pit. Operated by compressed air (90 -110psi) attached to a 'Push fit' connector on the foot pedal. **IMPORTANT: Compressor is not included and will need to be sourced/purchased separately.** Lifts should only be operated when the spa is fully drained of water, a safety latch automatically engages once the lift reaches the desired working height and requires manually releasing to then lower the spa back inground to resume normal operations. It should be noted that when choosing a lift, consideration should be given to the water and drainpipe connections, flexible water feeds can be used ensuring they are of sufficient length for travel and do not become trapped. A permanent drain positioned in the base of the pit can act as both rainwater and Spa drain which a floating drainpipe is installed.

## 3.2. Pre-Installation Testing

Before installing your Spa, Aquatica highly recommends you take the following steps to pre-test your unit and avoid expensive installation and uninstall costs in the event you discover an issue with your Spa.

Where possible, place your Spa in an area where you can access water from a hose and where it is possible to drain the spa once complete. Where possible, temporarily connect an electrical connection to ensure the system parts of your spa and fully functioning.

- Block off the drain hole (use gorilla tape or equivalent)
- Connect the electrical supply ensuring that the connection is enclosed in a waterproof connection
- Fill the spa with water
- Switch on the electrical supply and allow the spa to prime, test the features of the spa
- Drain and disconnect the spa, dry the inside and either transport to its final installation site or repack and fully protect for storage.

### 3.3. Electrical Guidance

**IMPORTANT: ELECTRICAL WORK SHOULD ONLY BE PERFORMED BY A SUITABLY TRAINED, COMPETENT AND CERTIFIED ELECTRICIAN.**

#### ELECTRICAL REQUIREMENTS

- All 240-volt spas must be permanently connected (hard wired) to the power supply, supplying power to the spa that is not in accordance with these instructions will void the Aquatica warranty.
- The power supplied to the spa must be from a dedicated circuit with no other appliances or lights sharing power.
- Wire size must be appropriate as per local codes. Wire size is determined by length of run from breaker box to spa and maximum current draw.
- We recommend copper wire with THHN insulation.
- All wiring must be copper to ensure adequate connections. Do not use aluminum wire.
- When using wire larger than 10mm<sup>2</sup>, add a junction box near the spa and reduce to short lengths of 10mm wire between the junction box and the spa.
- The electrical supply for the spa must include a suitable rated switch or circuit breaker to open all ungrounded supply conductors to comply with National Electric Code. The disconnecting means must be readily accessible to the spa’s occupants but installed at least 1.5 m from the spa water.

**IMPORTANT: Check with local municipalities for additional code requirements.**

- The electrical circuit for the spa must include a suitable Residual Current Device (RCD).
- The 240-volt models require a 50 or 60A, dual pole circuit breaker in the main electrical service panel. The 50 or 60A RCD breaker can be installed in the subpanel in the vicinity of the spa, but it should not be closer than 1.5 m from the spa water.

Aquatica spas have been prewired to a central waterproof connection box located inside your spa (specific location for your model can be found on the spa drawings).

All spas are wired to 220V using 1 hot wire L1, a neutral (N), and earth (ground) wire (G).

#### JUNCTION BOX WIRE COLOR MARKINGS:

- BLACK – L1
- WHITE – Neutral (N)
- GREEN – Earth (G)

*(Pictures are for illustration purposes only)*



**G.F.C.I. TROUBLESHOOTING:**

Keep in mind that a majority of Residual Current Device (RCD) tripping problems can be attributed to incorrect wiring. Residual Current Device (RCD) troubleshooting usually finds the problem.

If correct wiring is verified

- Check to see if the proper RCD is installed.
- Be sure the RCD is rated for more amperage than the system will draw.
- For a detailed wiring checklist, please review the previous segment of this manual on proper RCD wiring or the RCD manufacturer’s instructions (see below diagram for reference only).
- If the wiring is correct and the RCD will not reset, then unplug the pump and try to reset the RCD.
- If the RCD trips again, then unplug the blower and reset the RCD. If the RCD continues to trip, then do the same procedure for the UV Sanitizer lamp.
- If the RCD stops tripping after you unplugged one of the spa’s components, turn off the power to the spa then plug in each component except the one that tripped the RCD.
- Power up the system. If the RCD no longer trips, then you have correctly identified the problem.
- Repair or replace the component as instructed by the spa manufacturer.
- If you have unplugged all the spa’s components and the RCD still doesn’t reset, then the problem is most likely a ground fault in the heater.

**To disconnect the heater**

- First, turn off the main circuit breaker, then remove both heater straps or wires from the SPA system heater output, not the heater itself.
- After restoring the power, try to reset the RCD again. If it no longer trips after the system calls for heat, then replace the heater.
- If everything seems to be in perfect working order, then the RCD may be defective.

**220 VOLT RESIDENTIAL WIRING SCHEMATIC WITH RCD.**

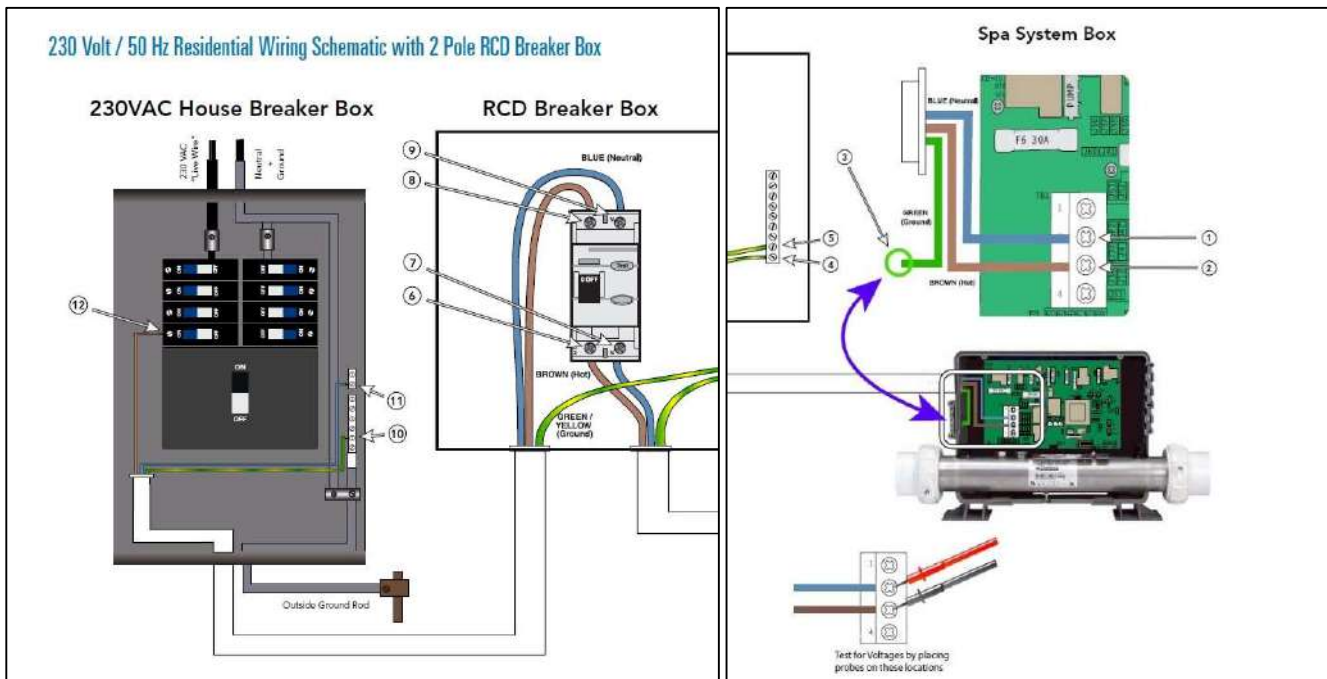

**Note:** This applies to all Domestic BP Systems. A BP2000 System is shown for illustrative purposes.

### 3.4. Plumbing Guidance

Depending on your Aquatica spa model and configuration, the plumbing connection will vary.

Infinity spas will have auto 'Fill and Drain' system fitted as standard; 'Fill and Drain' is also an optional extra available on all other spa models. For Spa's fitted with Auto 'Fill and Drain' a permanent water connection is necessary to ensure the system can operate correctly. As part of the system on the inlet, an electronic ball valve will be located on the inside of the working area with a label marked "Inlet" the ball valve has a (G) 1 Inch female thread and plastic adaptor for (G) ¾ inch female connection, for cold or hot water connections, it's also possible to connect a "Tee" joint to allow for both hot and cold.

**Please Note:** Spa's using a pneumatic lift will require the use of flexible hose connection with enough free slack travel allowance for when the lift is operated.

Each spa model comes with a main drain valve. For auto 'Fill and Drain' systems this will be electronic and will operate from the top side of the spa by following the steps listed in section 4.

For spas without 'Fill and Drain', there is a manual operated ball valve located near the base. Plumbing the drain to a waste line very much depends on the installation, whether that's hardline waste pipes or pumped to waste.

### 3.5. Spa Filling Guidance

Follow these steps to prepare your spa for water, please refer to section 4 for control panel (keypad) operating instructions.

#### PREPARATION AND FILLING

Fill the spa to its correct operating level. For spas with auto 'Fill and Drain' system the water will fill to the correct operating level automatically. For Spas with manual filling, it's recommended to fill within 100mm from the top rim of the spa.

Be sure to open all valves and jets in the plumbing system before filling to allow as much air as possible to escape from the plumbing and the control system during the filling process.

For spa's supplied with auto 'Fill and Drain' function, please ensure a permanent water line is connected to the connection point in your spa then follow the instructions as listed in section 4.

Once filled and after turning the power on at the main power panel, the top-side panel will display a splash screen or startup screen.

#### PRIMING THE SPA PUMPS

*Please note, this instruction is an example (for Balboa SpaTouch 3 keypads), you should follow instructions on your keypad to complete this activity.*

##### Priming Mode

After the initial start-up sequence, the control panel will enter Priming Mode and display a Priming Mode screen. Only pump icons appear on the priming mode screen. During the priming mode, the heater is disabled to allow the priming process to be completed without the possibility of energizing the heater under low-flow or no-flow conditions. Nothing comes on automatically, but the pump(s) can be energized by selecting the "Jet" buttons. If the spa has a Circ Pump, it can be turned on and off by pressing the "Circ" button during Priming Mode.

##### Priming the Pumps:

As soon as the Priming Mode screen appears on the panel, select the “Jets 1” button once to start Pump 1 in low-speed and then again to switch to high-speed. Also, select the other pumps, to turn them on. The pumps should be running at high speed to facilitate priming. If the pumps have not primed after 2 minutes, and water is not flowing from the jets in the spa, do not allow the pumps to continue to run. Turn off the pumps and repeat the process. NOTE: Turning the power off and back on again will initiate a new pump priming session. Sometimes momentarily turning the pump off and on will help it to prime. Do not do this more than 5 times. If the pump(s) will not prime, shut off the power to the spa and call for service. **IMPORTANT:** A pump should not be allowed to run without priming for more than 2 minutes. Under NO circumstances should a pump be allowed to run without priming beyond the end of the 4-minute priming mode. Doing so may cause damage to the pump and cause the system to energize the heater and go into overheating condition.

**Exiting Priming Mode:**

The system will automatically enter the normal heating and filtering at the end of the priming mode, which lasts 4 minutes. You can manually exit Priming Mode by pressing the “Back” button on the Priming Mode Screen. Note that if you do not manually exit the priming mode as described above, the priming mode will be automatically terminated after 4 minutes. Be sure that the pump(s) has been primed by this time. Once the system has exited Priming Mode, the top-side panel will display the Main Screen, but the display will not show the water temperature yet. This is because the system requires approximately 1 minute of water flowing through the heater to determine the water temperature and display it.

## 4. Operating Instructions

Depending on your spa configuration, your Aquatica spa will include a stylish and easy to use Balboa (Spa Touch 3 or 4) or Gecko keypad. Please consult Aquatica for further information on the configuration of your spa. All keypads are pre-programmed at the factory.

Keypad variations:

**Balboa SpaTouch 3**



**Balboa SpaTouch 4**



**Gecko in.k1000**





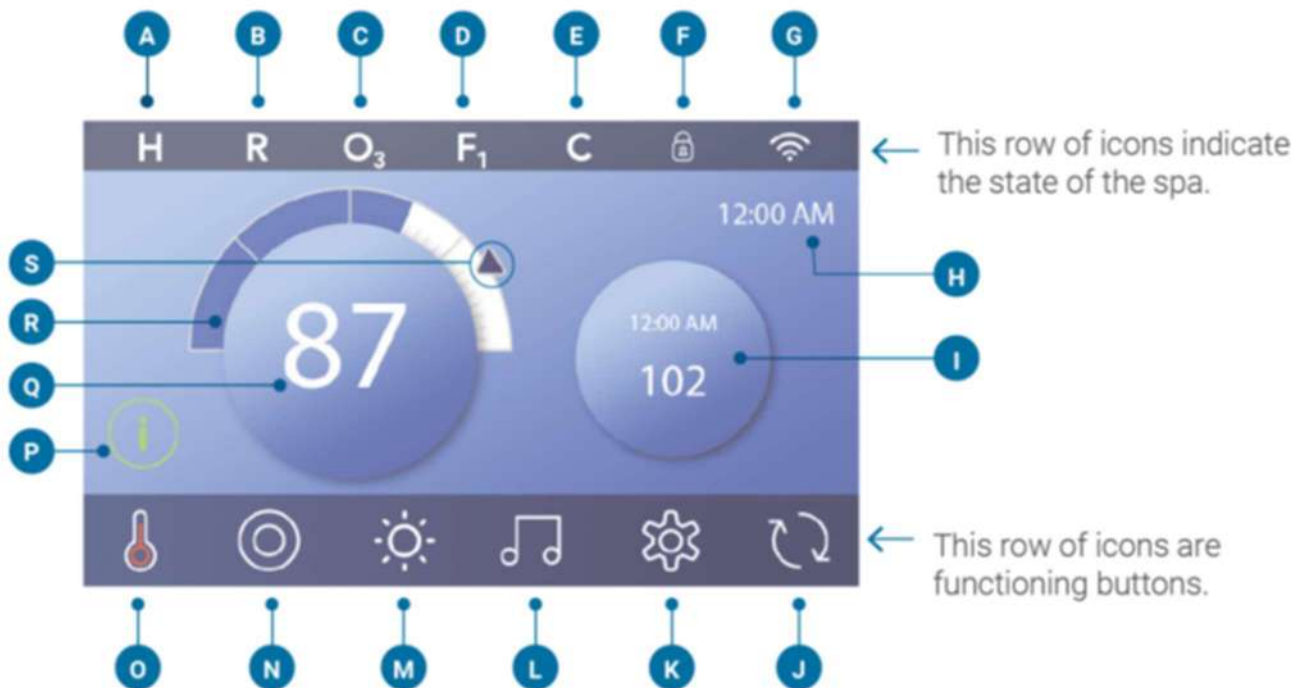

### 4.1. Control panel – Balboa Spa Touch 3 Keypad

This section includes some information regarding the functionality of your keypad, for the full manual, please visit: <https://www.balboawatergroup.com/SpaTouch3>. **IMPORTANT:** please download and read the full manual from the manufacturer’s website, which includes important additional instruction (such as filter cycle setup).

#### GENERAL SCREEN LAYOUT



### Main Screen Icons

- A** - Temperature Range  
High: **H**  
Low: **L**
- B** - Heat Mode  
Ready: **R**  
Rest: **☒**  
Ready-in-Rest: **RR**
- C** - Ozone Running: **O<sub>3</sub>**
- D** - Filter Cycles  
Filter Cycle 1: **F<sub>1</sub>**  
Filter Cycle 2: **F<sub>2</sub>** (Optional Feature)  
Filter Cycles 1 & 2: **F<sub>+</sub>**
- E** - Cleanup Cycle (Optional Feature)
- F** - Panel Locked and/or Settings Locked
- G** - WiFi (Local or Cloud Connection)
- H** - Time-of-Day
- I** - Secondary Button/Display
- J** - Invert Display
- K** - Settings
- L** - bba™ versions 2 and 3 (Balboa Bluetooth Audio)
- M** - Light (or CHROMAZONE™  if installed).  
Both icons change from white to color when these devices are powered On.
- N** - Spa
- O** - Heater Status
- P** - Message Button (May Appear)  
Information:   
Reminder:   
Error - Normal Error or Warning:   
Error - Spa will not function until fixed: 
- Q** - Water Temperature
- R** - Water Temperature Bar
- S** - Set Temperature Arrow

*The system configuration determines the number of icons that appear on the Main Screen. Your Main Screen may have fewer or different icons.*

### SPA STATUS

Important information about spa operations can be seen on the Main Screen. Most features, including Set Temperature adjustment, can be accessed from this screen. The actual water temperature can be seen, and the Set Temperature can be adjusted. Time-of-Day, Ozone and Filter status are available, along with other messages and alerts. A Lock icon  is visible if the Panel and/or Settings are locked. Near the bottom of the screen, at certain times an indicator may appear showing that a message is waiting. Touch this indicator to go to the Message Display Screen. On that Screen some of the messages can be dismissed.

When the spa is powered On, four dashes appear (A) in the Water Temperature display for one minute. The dashes indicate that the spa is checking the water temperature. After the pump runs for 1 minute, the dashes disappear, and the water temperature is displayed (B). The dashes may reappear after the pump has not run for one hour.

Please Note: When setting the water temperature, the keypad will not exceed 40 °C. The water in a spa should never exceed 40 °C. Water temperatures between 38 °C and 40 °C are considered safe for a healthy adult. Lower water temperatures are recommended for young children and when spa use exceeds 10 minutes.





**WAKE UP THE PANEL, NAVIGATION and COMMON BUTTONS**

Controlling your spa is easy with the intuitive graphical user interface (GUI).

**Wake up the panel:**

The screen is blank when it is in sleep mode. When you touch the blank screen, one of three screens will appear:

- The hand icon will appear. Wake up the panel by pressing the hand icon (A1) and then swiping in the direction of the arrows.
- The icon will appear (A2). Wake up the panel by pressing the icon.
- The Main screen will appear (A3). The panel is awake

The panel automatically goes into sleep mode when it is not used for a specified duration. The duration can be adjusted.

**Buttons:**

A variety of button styles provide quick access to functions and settings. The large temperature display button (B) that controls the Set Temperature.

The whole bottom row of the Main screen contains buttons (C).

**Screen names:**

Screen names appear in the top row of the screen. For example, this is the Settings screen (J).

**Navigation:**

Navigate screens and/or lists with the following buttons:



**Swiping and selecting items in lists:**

Swipe a list (N) to find the setting you want. The list will have an arrow that indicates the current setting. If your desired setting appears but is not aligned with the arrow, tap the desired setting to make it align with the arrow. The temperature list will disappear when you tap anywhere outside of it.

**Saving and canceling:**

After you input a new setting, press the Save button (B). After you press Save, the change is complete. If you don't want to apply a new setting, press the Cancel button (A).

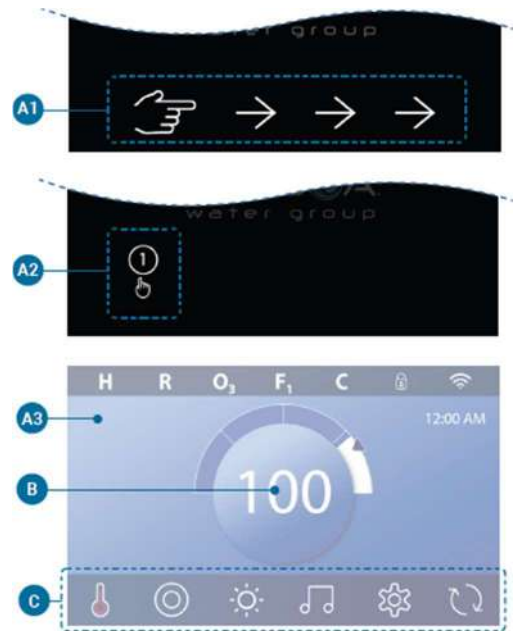

**Message buttons:**

Message buttons provide reminders to help you keep your spa running smoothly. Message buttons also provide warning information that helps spa technicians with troubleshooting. When a message button appears (C), press it to view the corresponding message (D) or (G). Press the Exit button (E) to go back to the Main screen or press the Clear button (F) to dismiss the message.

Buttons vary depending on the type of message.

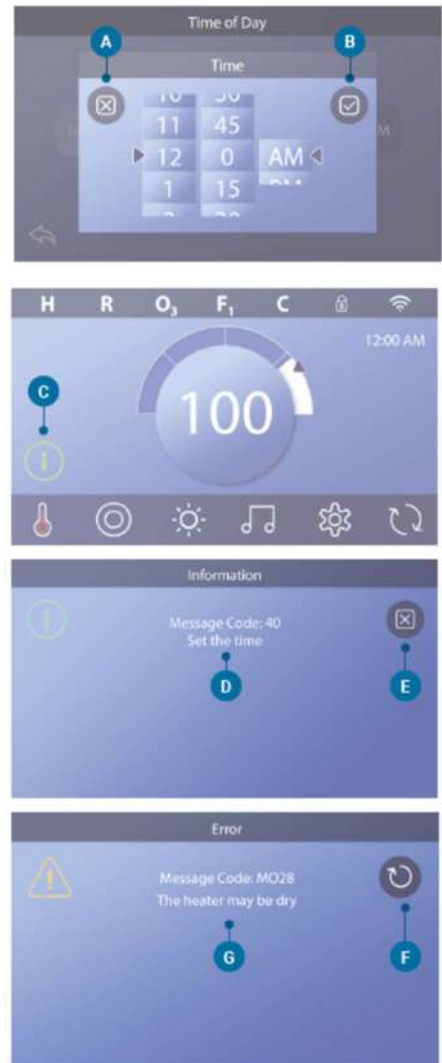

**SET THE TIME-OF-DAY:**

- In the Main screen, press the Settings button (B)
- In the Settings screen, press the Time button (C).
- In the Time-of-Day screen, press the Time button (D).
- Setting dials appear. Swipe these dials (F) to set the time. If your desired time value appears but is not aligned with the arrow, tap the desired time value to make it align with the arrow.
- Press the Save button (G) to save your settings. Or press the Cancel button (E) to cancel your settings.

Setting the time-of-day is important for determining filtration times and other background features. If Time-of-Day needs to be set, the Information Message button (A) appears on the Main screen; view the previous page for more information on the different types of Message buttons.

NOTE: If power is interrupted to the system, Time-of-Day will be maintained for several days (this only applies to some systems).

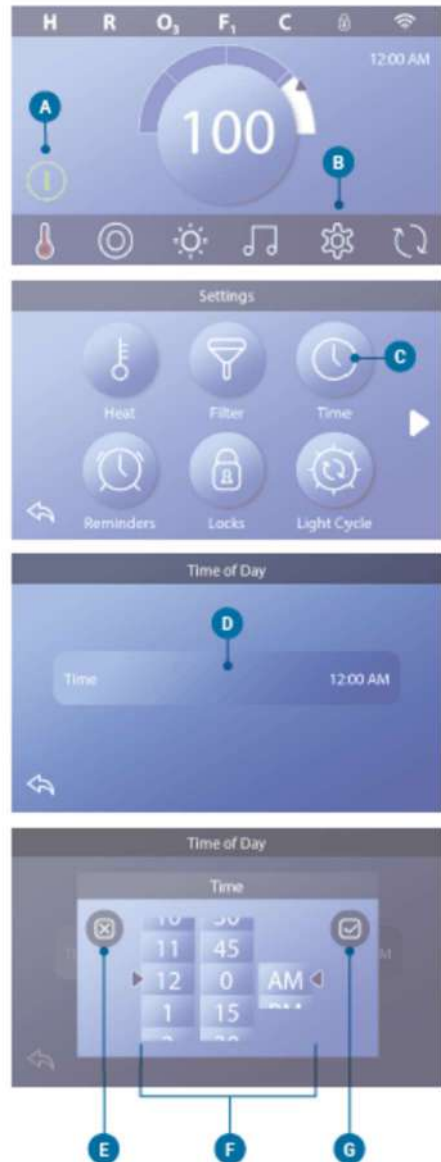

**SET THE TEMPERATURE:**

In this example we will set the Set Temperature to 102.

- Press the water temperature display button (A) to make the temperature menu appear (B). The center box with the arrow (C) indicates the current Set Temperature.
- If 102 is already showing, but not centered (D), touch it to center it (E). *Pressing 102 makes it shift to the center box (E).*
- If 102 is not showing (B), swipe the temperature menu until 102 appears (E).

Press the water temperature display (A) to make the temperature menu disappear. The Set Temperature is now 102.

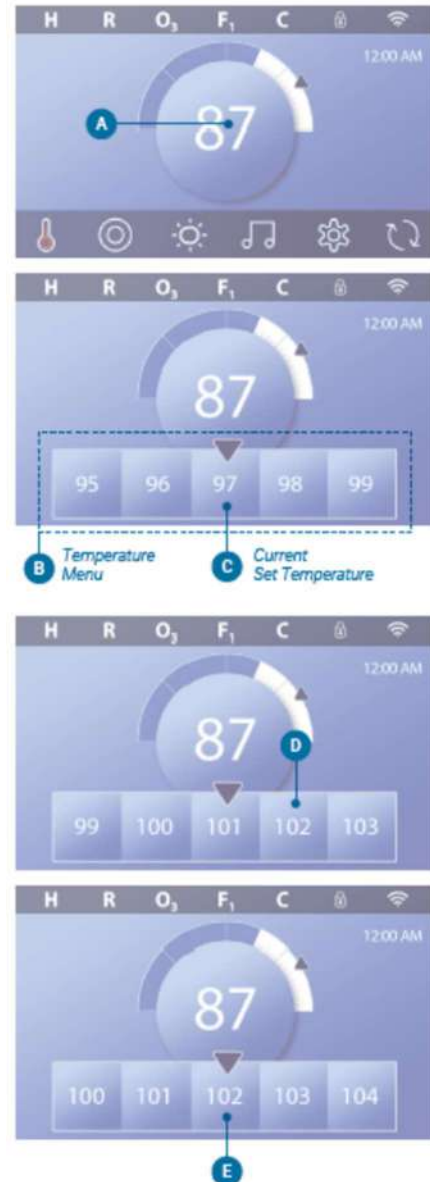

**View the Set Temperature**

Press the Heater Status button (A), and the Set Temperature appears in the Mini Player button (B). Press the Heater Status button again to make the Mini Player button disappear.

Set Temperature is represented numerically and by an arrow (D). Water temperature is represented numerically and by a blue status bar (C).

The difference between water temperature and Set Temperature is represented by the gap between the blue status bar and the arrow (E). If there is no gap, the water temperature and Set Temperature are equal.

**Change the Set Temperature with the mini player button?**

The mini player button and temperature display button function the same way in this regard. Press the mini player button to view the temperature menu. Select the desired temperature and press the mini player button again to make the temperature menu disappear. You have now programmed a new set temperature.

**How do I know when the heater is on?**

The center of the Heater Status icon turns red (A) when the heater is On. The Heater Status icon appears in the top left corner of the Spa screen (F) when the heater is On.

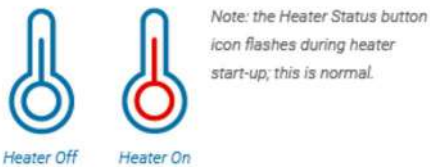

Please note due to the location of the water temperature sensor in your spa, readings from an external thermometer may not match the temperature indicated on your spa.



**USING MESSAGE CONTROLS (PUMP / JETS)**

Press the Spa button (A) to view the Spa screen.

Press buttons (B) to run spa devices.

Some devices may only turn On and Off, while other devices may have multiple speeds (which can be actioned by pressing the button twice).

Your spa configuration determines the number of buttons and the function of the buttons in the Spa screen. This is pre-set in the factory, and could be 2 jets or 2 jets and blower, etc.

- Jets buttons – hydromassage (water jets)
- Blower – air massage (air jets)

Press the Back button (C) to navigate to the Main screen.

If the Jets are left running, they will turn off after a time-out period.

Your Spa has a circulation pump, a circulation pump icon may appear in the Spa screen to indicate its activity only (the icon is not a functioning button). The circulation pump can be controlled with a button during Priming mode only.

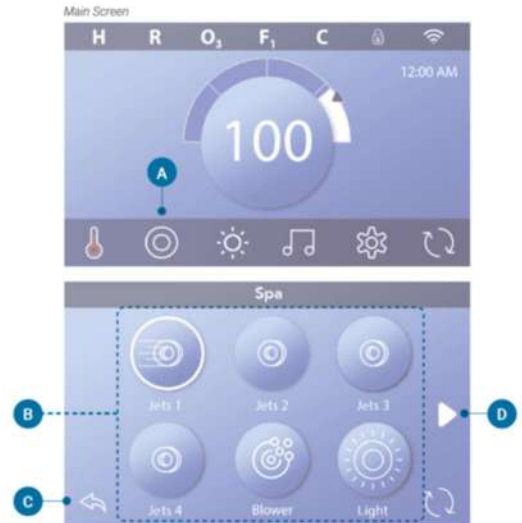

**USING LIGHT CONTROLS**

Spa lights will come on automatically when the spa is switched on. To control light settings (e.g. color) or switch off lights, select the lights icon on the main page.



## 4.2. Control panel – Balboa Spa Touch 4 Keypad

This section includes some information regarding the functionality of your keypad, for the full manual, please visit: <https://www.balboawatergroup.com>. **IMPORTANT:** please download and read the full manual from the manufacturer’s website, which includes additional important instructions (such as filter cycle setup).

### GENERAL SCREEN LAYOUT

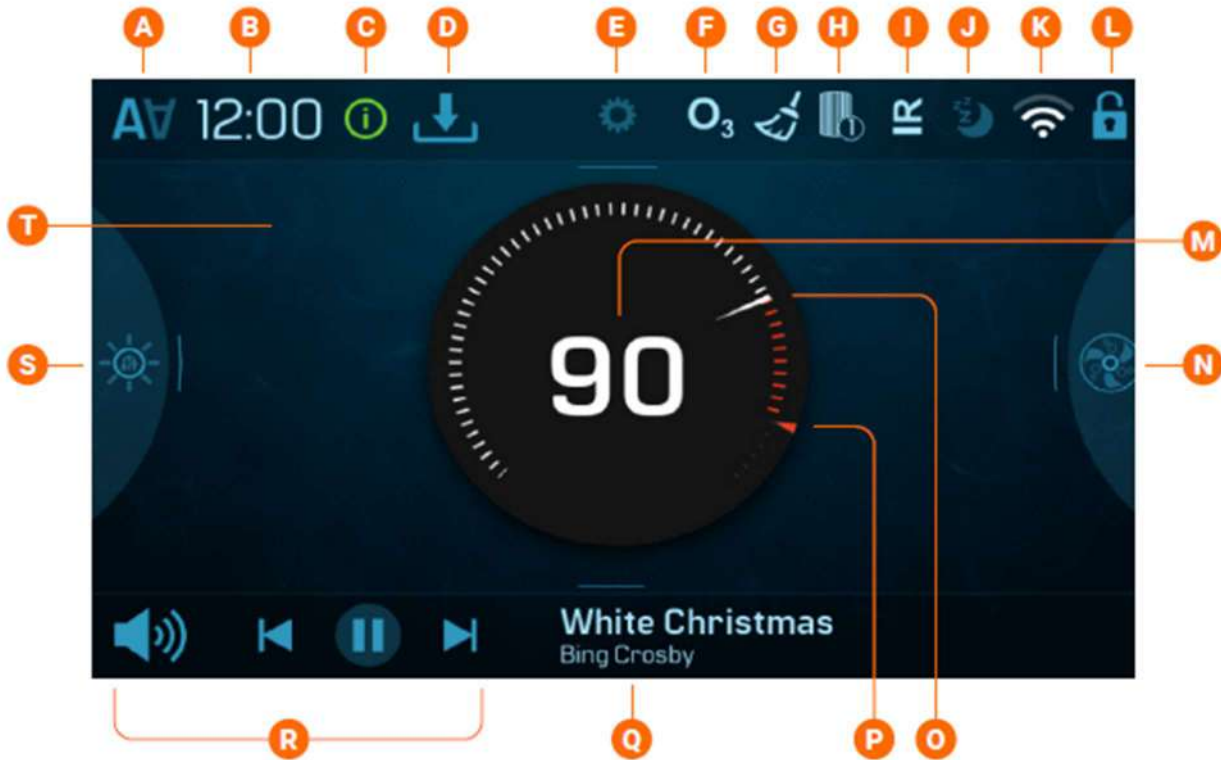

- A - Invert display
- B - Time
- C - Message (may appear)
- D - Download software update
- E - Settings
- F - Ozone is running
- G - Cleanup cycle
- H - Filter cycle 1 or 2
- I - Heat mode
- J - Sleep mode
- K - Balboa Worldwide App or ControlMySpa connected (local or cloud connection)
- L - Panel is locked and/or Settings is locked

- M - Water temperature display and control button
- N - Spa device controls
- O - Water temperature indicator
- P - Set temperature indicator
- Q - Music song and artist
- R - Music controls
- S - Spa light controls
- T - Home screen

**INTERFACE and NAVIGATION**

- A - Swipe down here to view the Settings menu.
- B - Swipe right here to view the spa devices screen.
- C - Swipe up here to view the music controls (if available).
- D - Navigate back to the Home screen.
- E - Increase/decrease display brightness.
- F - Navigate to previous screen.
- G - Enter the Time screen.
- H - Toggle button.
- I - Enter the Language screen.
- J - Swipe up/down to review the list.
- K - Toggle buttons.
- L - Save changed setting.
- M - Swipe up/down to change the settings.
- N - Cancel changed setting.
- O - Swipe up/down to view the Setting menu.
- P - Settings screen
- Q - Swipe right here to view the Chromazone screen.
- R - Change the Set Temperature.
- S - View the message screen.
- T - Swipe down to go back to the Home screen.
- U - Spa screen.
- V - These icons represent available Spa screens.

NOTE: Not all control systems are configured the same. Spa devices, Settings, and various menu items may vary on your control panel.





**VIEW SETTINGS**

Swipe down (A) to view the Settings screen (B).

*NOTE: not all control systems are configured the same. Spa devices, Settings, and various menu items may vary on your control panel.*

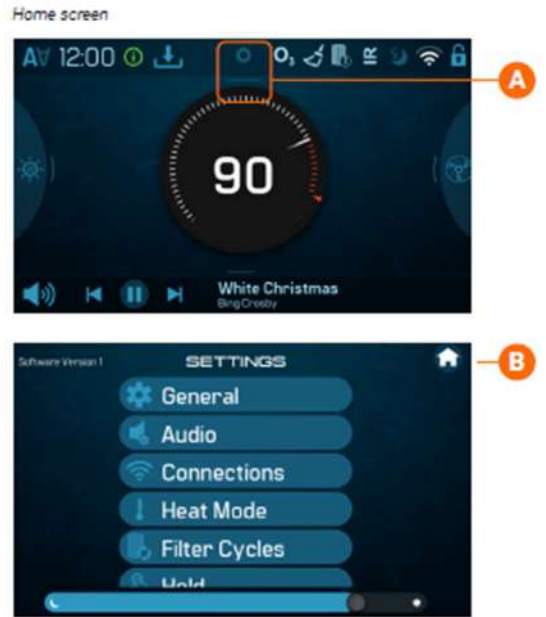

**SET THE TIME**

In Settings, select General

Press (G) to view the Time screen (H).

Set the time (I).

Cancel your settings (L) or save your settings (J).

The time appears on the Home screen.

Setting the time can be important for determining water filtration times and other background features.

If time has not been set, an information icon appears on the home screen, press it to view messages.



**SET THE TEMPERATURE**

Press the water temperature display/button (K) to view the temperature screen (C).

The water temperature is displayed in the center of the screen (J), and the Set Temperature is shown underneath (H).

There are two ways to change the Set Temperature.

- Press the plus and minus buttons (I)(D).
- Slide the Set Temperature icon (E).

Press the water temperature display/button (J) to go back to the Home screen. (A) represents the water temperature, and (B) represents the Set Temperature (B) on the Home screen.

**How do I know when the heater is On?**

The water temperature turns red (f).

**What do the dashes mean (G)?**

They indicate that the spa control has not checked the water temperature for approximately one hour. A pump needs to cycle water through the heater for the control system to check the water temperature. After water cycles through the heater for 1 minute, the dashes are replaced with the current water temperature. Whenever the control system is powered On, dashes appear (G) for one minute while a pump cycles water through the heater to check the current water temperature.



**USING MASSAGE CONTROLS (PUMP / JETS)**

Swipe (A) right to view the Spa screen (D).

Run the spa devices.

The functionality of each spa device may vary. For example, some devices may only turn On and Off, while other devices may have multiple speeds (which can be acted on by pressing the button twice).

Your spa configuration will determine the number of spa devices and the functionality of each device.

This is pre-set in the factory, and could be 2 jets or 2 jets and blower, etc.

- Jets buttons – hydromassage (water jets)
- Blower – air massage (air jets)

Your Spa has a circulation pump, a circulation pump icon may appear (C) in the spa screen, the icon is not controllable. It shows equipment status only. However, the circulation pump can be controlled with a button (F) during Priming mode (J).



**USING LIGHT CONTROLS**

Turn on/off lights (K).

If your spa is equipped with Chormazone™, swipe (K) left to view the Chromazone™ screen.



### 4.3. Control panel – Gecko in.k1000 Keypad

This section includes some information regarding the functionality of your keypad, for the full manual, please visit: <https://geckoalliance.com/products/in-k1000/>. **IMPORTANT:** please download and read the full manual from the manufacturer’s website, which includes additional important instructions (such as filter cycle setup).

#### GENERAL SCREEN LAYOUT



#### Sleep mode

Touch the screen to exit sleep mode, follow the instructions on screen to access main screen.  
3 minutes after the last pump is turned off, the screen will shut off if there is no touch activity.

#### Main screen

The main screen gives you access to your accessories and water temperature. At the bottom of the screen, you will see any error or maintenance messages that are present.

#### STOP and START ACCESSORIES

To start or stop an accessory, touch the associated icon. Icons will become animated when their accessory is turned on and animation will stop when turned off. Icons on the screen will reflect the speed or state of the devices running on your spa. When an accessory has more than one speed press the button until it reaches the desired speed.

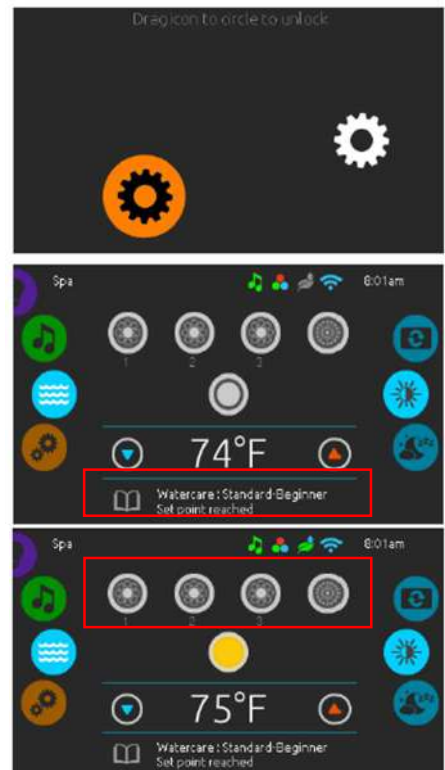

**WATER TEMPERATURE**

The temperature shown at the bottom of the screen indicates the current water temperature.

Use the Up and Down icons to set the desired temperature. The set point will appear in blue.



- After 3 seconds without any change to the set temperature value the current water temperature will reappear in white.
- When the set value is lower than the current temperature Cooling to xx.x will appear below.
- When the set value is higher than the current temperature, Heating to xx.x will be indicated under the value.



**SPA MENU**



Slide the wheel up or down on the right and left side of the menu until the desired icon is highlighted in the middle.

On the right side is a menu for access to the Display and Contrast pages, icons include:

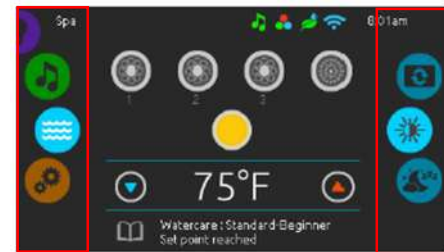
-  Display page – change keypad orientation
-  Contracts page - change contrast to night or day
-  Sleep mode



On the left side is a menu for access to Settings and Spa Functions, icons include;







-  Settings
-  Returns home screen to show water temperature

*Further items may be available / active dependent on Spa configuration*



Note: when an icon is selected on the left, ‘sub’ options will be displayed in the center of the screen and on the right side (orange icons)

**Settings**

In the Settings page you can access the following:

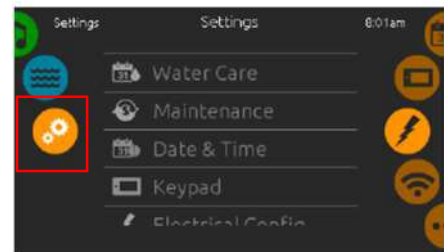
-  Water Care - set up your ideal filtration and heating settings
-  Maintenance – reminders and standby mode (for servicing)
-  Date and Time - change date and time
-  Keypad – change settings such as temperature units, language and locks
-  Electrical Config. - do not make any changes in this section unless you are a qualified electrician
-  Wi-Fi - connect to Wi-Fi if you have opted for in.touch add-on



-  Miscellaneous - modify the Warm Weather option and info messages in the media centre.
-  About – keypad software number

To select an item, slide the right wheel until the desired icon is highlighted in the middle or press on the menu name.

**WIPE SCREEN MESSAGE**

This message appears when too much water is detected on the touch screen. Simply wipe away excess water.



**4.4. Auto Fill and Drain (Optional Extra)**

The auto fill and drain add-on can be opted for when ordering the spa. The spa will be supplied with an auto-managed water controller, level switch and electronic draining. Spas equipped with the Auto Fill and Drain system are activated using the two round switches next to the keypad display, red and blue.



The blue represents the auto-managed water system that will top up water whenever the water level drops and shuts off the water supply once filled to operational levels. The red indicates power is disconnected from the spa pack. When the switches are in the down position (as shown in the pictures above), they will illuminate red and blue. When both switches are illuminated, the spa is powered off and the drain valve is open.

**IMPORTANT:** When installing it for first time use, ensure both buttons are in the down position illuminating red and blue. Always start with activating the water system first by placing the blue switch in its up position (as shown in picture 1 below), the blue light will turn off, the drain will close, and the spa will begin to fill with water. Once the spa has stopped filling, power the spa by placing the red switch in its up position. The red light will turn off and the display will power on.

When emptying the spa, always power off the spa first by placing the red switch in its down position so it lights up red, then proceed to the water management switch to its down position so that it lights up blue. The display will power off and the spa will begin draining. Step by Step instructions below:



Picture 1:

**FILLING YOUR SPA**

- Ensure both buttons are in the down position
- Press the BLUE button to the up position, this will open the water valve and automatically fill your spa to a preset level controlled by water level sensors.
- Once the water level has been reached press the RED to the up positions, this will engage power to the spa and start the priming process.
- From here the spa will function and will automatically top up the water level as required from general use water loss.

## DRAINING YOUR SPA

- First disengage the power by pressing the RED button in the down position. This protects your spa by preventing the pumps and heater from working while you drain the water  
**WARNING:** The above action only prevents your spa from operating, the Live Electrical feed to your spa is still Live and can only be isolated from the main breaker panel.
- After pressing the RED button down. Press the BLUE button to the down position, this engages the electronic drain valve to open and empty the water.

The electronic valves fitted to your fill and drain system will remain closed should you experience any power outage; this will prevent your spa from filling or emptying until power is restored. However please note that the valves have solenoids which are energized for opening and closing, when operated, the valve needs a minimum of 30 seconds to re-energize, if the solenoids are not fully energized the valves may not fully open or close.

## 4.5. Pneumatic Elevator for Built in Spas (Optional Extra)

This machine is operated by pressurized air from an air compressor (not included) to the lift, which delivers the pressure to a heavy air cylinder at the bottom of the platform to provide lifting pressure.

Our lift has been chosen with sufficient lift capacity (700kg.) to safely lift an empty spa. Please note, it's important to ensure the water has been emptied before you attempt to lift your spa.

An air compressor will be needed to operate your lift (Air Compressor not included with your purchase). The air compressor should have a capacity to supply 90 – 110 psi of air pressure to operate the air cylinder.

Compressed air should be supplied to the special ¼' NPT push-fit connector on the foot pedal which when pressed delivers air to the cylinder to allow lifting operation.

**SAFETY ALERT:** Please ensure that the locking device engages in place when raising the lift. The locking device should be manually released via the side mounted ring and foot pedal which slowly lowers the lift back to its resting position:

1. Lift the spa to the max. top position
2. Pull the ring up to release the locking device
3. Slowly lower the lift back to its resting position



Make sure the lift is used on a level, concrete surface capable of supporting the weight of the lift. DO NOT use the lift on concrete expansion seams or on cracked, defective concrete.

Overall dimensions, length, width and height will depend on the Aquatica Spa model you have purchased, specific drawings can be obtained by request from our sales representative or downloaded from our website. Please note sizes and weights may vary slightly from those shown. Aquatica DOES NOT accept liability for the construction of any In-ground pit, special sidings or finished floor level.

Pneumatic Elevator (lift) is meant to aid for servicing purposes only, the lift should only be used when the spa has been emptied of water. Once the water has been emptied and the airline connected to the foot pedal and lift operated. The lift will raise the spa from its resting position out of the ground giving enough access for the service engineer to reach all system components for service or repair.

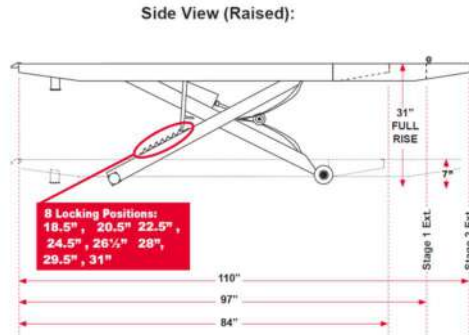

The Pneumatic elevator is operated by connecting compressed air to the foot pedal as per the picture below. The foot pedal is connected to the pneumatic cylinder via a pre-installed hose which is approximately 1.9 meters long. When designing and constructing the pit or housing for your spa, allowance should be made for the position and access of the foot pedal.



#### 4.6. Bluetooth Audio (Optional Extra)

If you have chosen a spa with Bluetooth audio (BT Audio) you can connect to it using any Bluetooth compatible audio device by searching for 'in.stream 2'. Password to access will be 5555. From your audio device it will now be possible to listen to your music or other audio while relaxing in your spa, Speaker arrangement depends on your spa model.

- Downtown models feature 360° pop up speakers and a subwoofer.
- Vibe models feature several Audio Sound Transducers turning your spa into a speaker and subwoofer.

#### 4.7. Second Heater (Optional Extra)

A second heater can be fitted within the circulation system to increase the water heating power and reduce the heating time when water is being exchanged on a regular basis. It's recommended that a second dedicated 220-volt power line, with 20Amp breaker be fitted to power the additional heater which draws 3,6kw / 16A. When selecting your spa temperature (via the keypad) both heaters will activate to heat your spa to your selected temperature.



### 4.8. Auxiliary Heater/Chiller (Optional Extra)

A good way to reduce your energy consumption and give you flexibility over the heating and cooling of your spas water. The Auxiliary heater/Chiller is a stand-alone heat pump which can be mounted away from the spa to avoid nose distractions, although the heat pump operates quietly at less than 50dBA. Additional plumbing work will be required for installation (Flow and Return) pipes which can connect into the spa’s circulation pipework. The CLIM8ZONE™ heat pump plugs directly into the spas operating system and can be controlled by the keypad.



**Set the temperature mode**  
Press the Clim8zone™ button to enter the Clim8zone™ screen

**Select a Temperature Mode**  
Heat only, Cool only, Heat and Cool (default) or disabled

**Save Your Setting**  
Press the save button to save your setting or the cancel button to cancel your setting

### 4.9. Aromatherapy (Optional Extra)

Create the ultimate spa experience by adding the aromatherapy package to your outdoor Spa or Spa bathtub purchase. Breathe deeply in, allowing soothing scents such as Clary Sage, Eucalyptus Mint, Lavender and calming Chamomile to transport you away to another world of pure relaxation and tranquility. The special aromatherapy package complements your therapeutic hydromassage and chromotherapy experience, providing you with the opportunity to benefit from the ultimate spa treatment without leaving your home. Simply put your desired Bead Sents into the spa and your aromatherapy will begin to circulate.

*Appropriate Bead Sents include Balboa Water Pt nr Bead Scents (10404-V) or equivalent*

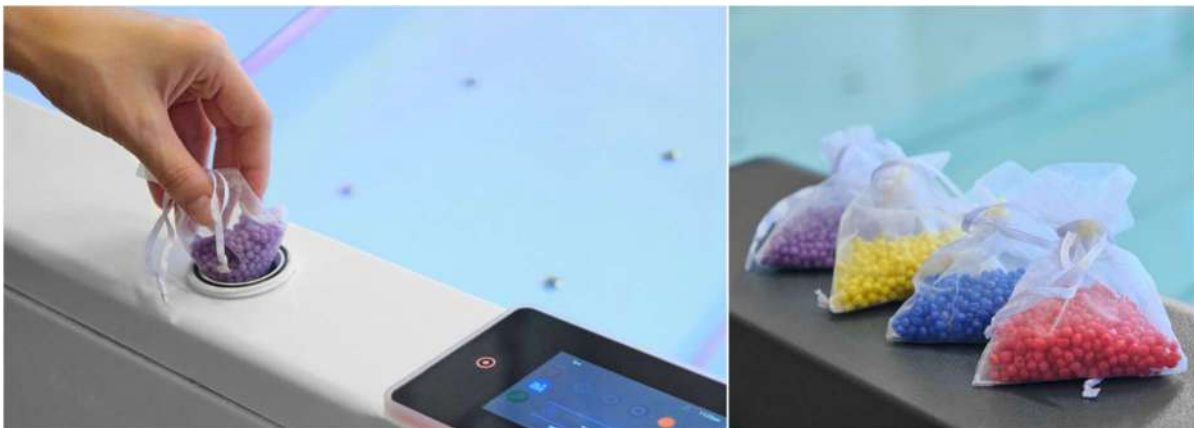

*Refill Aromatherapy scents can be purchased from your local Spa and Pool supply store or from Amazon.com. Please do not use oils directly into your spa.*

#### 4.10. Active Hydromassage (Optional Extra)

(Only Available on Vibe models):

The Active Hydromassage option allows bathers to experience complete weightlessness, while receiving a deeply stimulating water massage. Extra Vortex Minijets are added to the Spa to create an active therapy floating seat. This delivers an intense hydromassage, reaching all muscles and trigger points, like a massage therapist rubbing and kneading the body using hands. Active Therapy helps to unknot tight muscles and offers significant pain and ache relief.

Active hydromassage is controlled using the standard jet controls from your keypad.

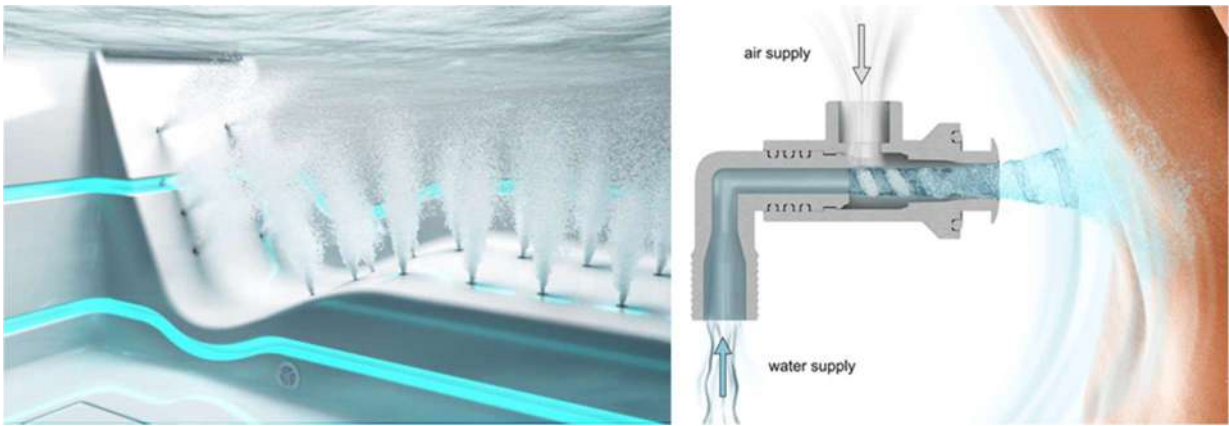

## 5. Maintaining your Spa

### 5.1. Protecting your Spa

Using a spa cover will not only help with maintaining water temperature and prevent leaves or other airborne objects from falling into your water, also a cover will help shield the gel-coated surfaces from the UV light which can cause discoloration or promote surface blistering.

### 5.2. Spa Cleaning

Fiberglass Spa care is aimed at preventing persistent dirt and avoiding the damage of the surface layer. To take proper care of your fiberglass liner, you need to purchase soft microfiber sponges and fabrics. Also, it is necessary to use special products. Detergents can be particularly dangerous for fiberglass Spa if they contain concentrated alkalis and acids, chlorine and ammonia. These substances can change the bath colour, lead to the appearance of small cracks and scratches and make the smooth surface rough.

#### CHOOSING THE RIGHT CLEANING SOLUTION

It is better to select fluids with a cleaning effect to properly maintain the fiberglass liner. They may be:

- Special products for fiberglass, including non-abrasive paste. Abrasive paste contains particles like small sand grains which can damage fiberglass. Before using any paste, squeeze its small amount onto your finger and rub it, you'll see sand grains immediately.
- Liquid soap
- Shower gel
- Dishwashing liquids are one of the most popular options, as they remove most grease and oil stains.

**IMPORTANT:** Don't use dishwasher detergents, they may be too hard for fiberglass. There shouldn't be bleach in the detergent or cleaner. To remove any lime scale and rust, use only special products for dishes or fiberglass/acrylic baths. In case of their accidental application, wash off chemical active substances with cold water. High temperatures increase the reaction rate, and the surface will be damaged faster.

#### USE APPROPRIATE CLEANING TOOLS

Avoid using brushes when cleaning the product regularly. They will scratch and destroy its gel surface.

- Gently rub your fiberglass cleaner with a cloth or soft nylon brush
- Move your tools circularly when cleaning fiberglass so you are less likely to scratch it.
- Use a sponge for particularly difficult stains.

**IMPORTANT:** Do not use steel sponges or sandpaper as they are too hard for fiberglass surfaces.

#### BE CAREFUL WHEN CLEANING FIBERGLASS

Exposure to fiberglass dust and cleaning agents can irritate your skin, eyes or respiratory tract. There won't be any serious health problems, but it may cause some discomfort. We recommend using gloves and a mask when cleaning fiberglass.

#### CLEANING THE WHIRLPOOL SYSTEM

The whirlpool system should be regularly cleaned and disinfected. If soapy foam, dirt and organic residues get into hoses, they start decomposing which leads to unpleasant smells. When the water circulates in the system, this dirt gets into the common tank, making the bathing procedure unhygienic. **IMPORTANT:** Do not leave unfilled SPAs in direct sunlight for prolonged periods of time as this can cause discoloration or damage to the Gel coated surface.

### 5.3. Water Quality

Taking care of your Spa may seem overwhelming initially, but understanding the basics of Spa chemicals can simplify your ownership and more importantly your health.

#### **WATER BALANCE**

The right balance of chemicals ensures your Spa stays clean, safe, and enjoyable for you and your loved ones. Proper Spa chemical balance is crucial for several reasons, as follows:

##### **Water Sanitation**

Chlorine and bromine are the primary sanitizers used in Spas. These chemicals neutralize harmful bacteria and other microorganisms that can cause illness and infections. Maintaining the right chlorine or bromine levels helps keep your Spa water clean and safe.

##### **pH Balance**

pH levels indicate how acidic, basic, or neutral your Spa water is. The ideal pH for Spa should be between 7.2 and 7.8. Too high or too low pH levels can cause skin irritation and damage Spa equipment. Regularly testing and adjusting pH helps maintain a comfortable water environment and prolongs the life of your Spa components.

##### **Alkalinity**

Total alkalinity measures the water's ability to buffer changes in pH. Proper alkalinity levels (between 80 and 120 ppm) help to prevent sudden fluctuations in pH. This ensures a more stable and comfortable water environment.

##### **Water Quality**

Properly balanced Spa chemicals help keep the water clean, clear, and free of unpleasant Odors. This ensures a more enjoyable soaking experience for you and your guests.

#### **ESSENTIAL CHEMICALS FOR SPA MAINTENANCE**

To keep your Spa clean, safe, and enjoyable, it's important to maintain balanced water chemistry. We've outlined the most essential chemicals you need for Spa maintenance, making it easier for you to create a healthy and pleasant spa experience. It's essential to establish a regular maintenance routine and testing schedule to ensure accurate chemical levels. By understanding the different types of chemicals used in Spa start-up and maintenance, you'll be able to maintain a clean, safe, and enjoyable Spa experience for years to come.

##### **Sanitizer**

A key component in Spa care is using a sanitizer, which comes in two main types: chlorine or bromine. Both options have their pros and cons, so choose one that best suits your preferences and maintenance habits. Sanitizers kill harmful bacteria, ensuring safe and clean water for soaking.

##### **pH Balancers**

Maintaining the proper pH level is crucial for balanced water chemistry. You'll need both pH increasers and de-creeaser to adjust the water's acidity or alkalinity. Strive for a pH level between 7.2 and 7.8 to prevent equipment damage and skin irritation.

##### **Alkalinity Increaser**

An alkalinity increaser stabilizes the pH level and prevents fluctuations. It maintains the water's buffering capacity, which helps to avoid sudden pH shifts, protecting your Spa components and ensuring bather comfort.

##### **Calcium Hardness Increaser**

Calcium hardness is essential for preventing calcium scaling on the Spa surfaces and equipment. A balanced calcium hardness level should range between 150 and 250 ppm for most Spas. Soft water can cause corrosion

in your Spa equipment, while hard water can lead to scale formation. A calcium hardness increaser helps you achieve the right balance, extending the life of your Spa parts and guaranteeing a more comfortable soak.

**Shock Treatments**

There are two types of shock treatments – chlorine shock and non-chlorine shock. These treatments help to break down contaminants and organic waste, restoring water clarity and preventing unpleasant Odors. A periodic shock treatment, depending on your Spa usage, can significantly improve water quality.

**THE SPA SANITIZATION PROCESS**

When you sanitise your Spa, it is essential to eliminate bacteria, viruses, and fungi. This provides you with a clean and safe environment to relax. It is important to remember that excessive chlorine can be harmful, and one must know how to manage chlorine levels for a safe Spa experience. There are three essential steps you need to take to sanitise your Spa:

**Step 1: Water Testing**

To sanitise your Spa, start by testing the water for sanitiser, pH and alkalinity levels. A proper water balance ensures the sanitiser works efficiently and prevents scaling, corrosion, and skin irritation. Here are the recommended levels for monitoring Spa water:

Parameter	Recommended Levels
pH	7.2 - 7.8
Alkalinity	80 - 120 ppm
Sanitizer	1 - 3 ppm (chlorine) or 3 - 5 ppm (bromine)

When it comes to maintaining the water quality in your Spa, regular testing is essential. We recommend using either test strips or liquid test kits for accurate readings of key water parameters. These tools help ensure that your Spa water is safe, balanced, and comfortable to soak in.

Test Strips: Test strips are a convenient and popular choice for Spa owners. They quickly measure the levels of pH, alkalinity, and sanitizer (such as chlorine or bromine) in your Spa water.

To use them, simply dip the strip into the water, wait for the specified time, and then compare the colour change on the strip to the provided chart. Many Spa owners appreciate the ease of use and fast results provided by test strips.

Liquid Test Kits: On the other hand, liquid test kits offer a more hands-on approach to water testing. These kits use reagents that react with your Spa water to produce colour changes, which are then compared to a colour chart. Liquid test kits can be more accurate than test strips, but they require more time and care to perform the tests correctly.

**Step 2: Adding the Sanitiser**

You need to add bromine or chlorine granules or tablets of sanitiser to your Spa, it’s essential to regularly test and adjust the sanitiser level to keep the water clean and safe. *Before testing, wait until the chemicals completely dissolve into the water.* In addition to this, shocking your Spa once a week helps break down organic contaminants and revitalise the sanitiser.

**Step 3: Cleaning the Spa Filter**

Don't forget to clean the Spa filter regularly. The filtration system is crucial in maintaining a clean and safe Spa. You need to clean your filters regularly to ensure they can efficiently remove particles and contaminants from the water.

**SPA EQUIPMENT AND MAINTENANCE**

For proper maintenance, it's important to have reliable equipment, such as a good filtration system and a Spa cover. A filtration system ensures the water stays clean and free of contaminants. A Spa cover prevents debris, dirt, and leaves from entering the water. This reduces the workload for the filtration system. Regular Spa

maintenance involves checking and adding chemicals to your Spa water. Testing kits are available to measure sanitiser levels, pH, alkalinity, and calcium hardness. Make sure to drain and refill the Spa, depending on your usage and environmental conditions to keep the water fresh and clean. Routine Spa maintenance doesn't have to be expensive or time-consuming. Many tasks can be done yourself with proper guidance and care.

## **COMMON PROBLEMS AND HOW TO FIX THEM**

Below are the 6 most common problems you can face using a Spa:

### **1. Cloudy Water**

One common issue Spa owner's face is cloudy water. Cloudy water can be caused by many factors, such as high levels of sanitiser, unbalanced pH, or dirty filters. To fix this problem, first test the water using test strips to ensure the balance is correct. You can then clear up cloudy Spa water by cleaning or replacing the filters and adjusting the chemical balance as necessary.

### **2. Algae**

Algae are another common problem that leads to green water in Spas. To prevent algae growth, it's essential to maintain the correct sanitiser levels and perform regular water treatments. If you're already dealing with green water, you can attack the algae by shocking the Spa, scrubbing the surfaces, and cleaning the filters.

### **3. Biofilm**

Biological contaminants, such as biofilm, can also cause issues in your Spa. This slimy layer may harbour bacteria and other organisms, leading to water quality problems. If not addressed, this can cause damage to the Spa surfaces. To fix biofilm or other contamination, ensure regular water testing and timely replacement of water if necessary.

### **4. Calcium Deposits**

Calcium deposits and scale buildup can occur due to hard water, ruining your Spa's appearance and causing damage to the equipment. To prevent this, test the water's hardness and treat it with a water softener if necessary. Using a chemical like O-Care can help you manage calcium deposits more effectively.

### **5. Foaming**

Skin irritation can happen if the chemical balance in the Spa is off. To avoid this, it's essential to maintain the proper balance of sanitiser, pH, and other water parameters. Test your water regularly and make necessary adjustments as instructed. Getting rid of Spa foam can also help, as foam can sometimes be a source of skin irritation.

### **6. Unpleasant Smell**

Unpleasant Spa smells can develop due to various factors like bacteria, algae, or chemical imbalances. To remove obnoxious Spa smells, ensure you regularly clean and balance your Spa water, addressing any issues as they arise. By addressing these common problems, you can maintain a safe, clean, and enjoyable Spa experience for you and your guests.

## **PRO TIPS FOR SPA OWNERS**

We've compiled essential tips and recommendations that every Spa owner should be aware of. Here are the main tips:

### **Understand Spa Chemistry**

Spa chemistry may seem intimidating at first, but it's simpler than you think. Familiarize yourself with the basics of pH, alkalinity, sanitizer levels, and various spa chemicals required to keep water balanced and clean.

**Create a Cheat Sheet**

To make your job as a Spa owner easier, we recommend creating a cheat sheet that outlines the essential tasks with the frequency of performing them, like checking and adjusting pH levels, sanitizing, and cleaning filters. This can serve as a quick reference guide to ensure you never miss a step.

**Choose the Right Sanitizer**

Select the right sanitizer for your Spa, typically choosing between chlorine and bromine. Each sanitizer has its pros and cons, so research and choose according to your preferences and needs. Chlorine and bromine both works effectively in keeping water free from bacteria and germs. Chlorine is a more common choice, but bromine is suitable for those with sensitive skin or allergies to chlorine.

**Store Spa Chemicals Properly**

Ensure that your Spa chemicals are stored correctly, away from direct sunlight, heat, and moisture. This will not only extend the life of the chemicals but also prevent any unwanted reactions between different products. Proper storage also helps you maintain a well-organized supply of chemicals for your Spa.

**5.4. Cleaning and Replacing Water Filters**

**DOWNTOWN SERIES:**

(EXCLUDING DOWNTOWN INFINITY)

Downtown series spas are equipped with a skimmer. The skimmer will contain a pleated filter cartridge. Debris is filtered by the circulation pump drawing water through the skimmer’s strainer basket and diverted through a filter cartridge. It is recommended to run the filtration cycle for 12 hours a day, 7 days a week. To ensure optimum performance, rinse the filter cartridge weekly and replace it every 6 months, or as needed. Cleaning the cartridge with a filter cleaning solution once a month will provide longer lasting performance.

**Accessing the Filter Cartridge**

- Turn off the Spa or perform when spa is in Stand-by mode. Circulation pumps should not be active.
- Hold the center grip on the weir door (pictured below) and open outwards.
- Reach inside and slide out the basket.
- Reach inside and remove the diverter plate.
- Reach down and slide out the filter cartridge.
- Clean or replace.
- Reverse the above steps for reassembly.

Replacement filters can be sourced from Spa and Pool Stores or Amazon.com

*Filter type: Spa-Daddy SD-00260 Filters or Waterways PWW10 filters*

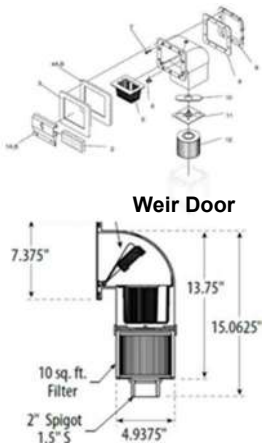

## DOWNTOWN INFINITY

Downtown Infinity spas are fitted with in-line filters large enough to manage the volume of water exchange. The Filter housing is located within the working area of your spa system and allowances should be made when locating your spa for easy access in filter care management.

It is recommended to run the filtration cycle for 12 hours a day, 7 days a week. To ensure optimum performance, rinse the filter cartridge weekly and replace it every 6 months, or as needed. Cleaning the cartridge with a filter cleaning solution once a month will provide longer lasting performance.

### Accessing the Filter Cartridge

- Turn off the Spa and isolate the filter using the gate valves.
- Unscrew the top of the filter housing.
- Gently pull the filters to remove.
- Clean or Replace filter cartages.
- Reverse the above steps for reassembly.

**Please Note:** some water will be present in the filter housing so a small amount of water will be lost. When restarting the Spa please remember to open the gate valves which were closed for filter maintenance. Due to the water within the filter housing an airlock could develop during start up, this air should be released to ensure filters do not become bypassed, this can be achieved by slowly opening the bleed screws located on the lid of the filter.

Replacement filters can be sourced from Spa and Pool Stores or Amazon.com

Filter type: *DLM-PRB50-1* or *PWW50L*

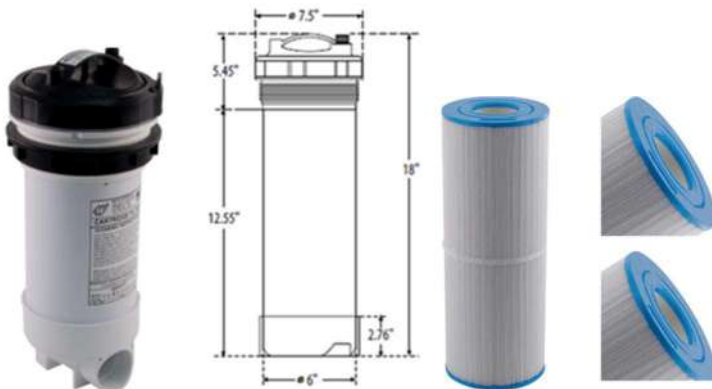

## VIBE SERIES:

Unlike the downtown series spas, Vibe series Spas are fitted with in-line filters large enough to manage the volume of water exchange. The Filter housing is located within the working area of your spa system and allowances should be made when locating your spa for easy access in filter care management.

It is recommended to run the filtration cycle for 12 hours a day, 7 days a week. To ensure optimum performance, rinse the filter cartridge weekly and replace it every 6 months, or as needed. Cleaning the cartridge with a filter cleaning solution once a month will provide longer lasting performance.

### Accessing the Filter Cartridge

- Turn off the Spa and isolate the filter using the gate valves.
- Unscrew the back part of the filter housing (colored white in the picture below)
- Gently pull backwards on the filters to remove.
- Clean or Replace filter cartages.
- Reverse the above steps for reassembly.



**Please Note:** some water will be present in the filter housing so a small amount of water will be lost. When restarting the spa please remember to open the gate valves which were closed for filter maintenance. Due to the water within the filter housing an airlock could develop during start up, this air should be released to ensure filters do not become bypassed, this can be achieved by slowly opening the brass-colored bleed screws at the front of the orange housing.

Replacement filters can be sourced from Spa and Pool Stores or Amazon.de

Filter type: Pentek ECP50-10 / Polystar 50.

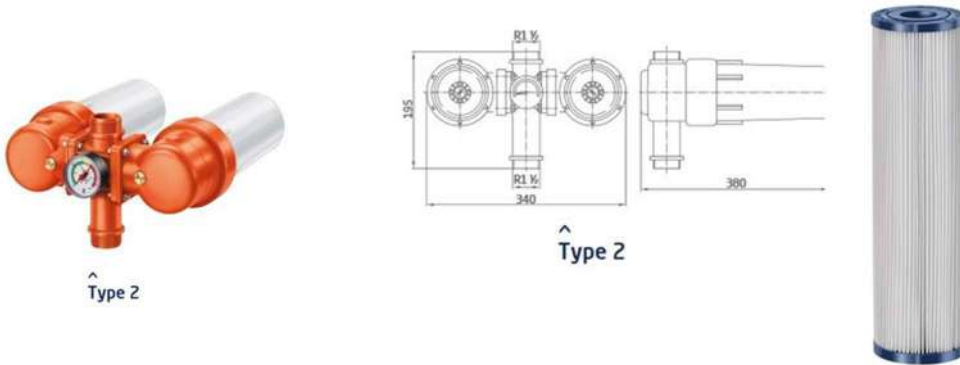

## 5.5. Winterization

Aquatica spa can be used all year round and there is nothing more relaxing than using your spa during the colder months. However, if you do choose to close your Spa for the winter, follow our 10 easy steps. Doing so will help avoid broken plumbing from freezing water and help to reduce start up time for the next season.

### TURN OFF POWER TO THE SPA

Before draining or servicing your Spa, it is critical that you shut off the power at the breaker. This will keep you and your Spa out of harm's way as you begin the closing process. Remember, electricity and water do not work well together, so use caution whenever you're working around your Spa's electrical areas.

### DRAIN THE SPA

Depending on the specification and equipment arrangement, the water should be drained from the Spa. A sump pump can also be used although its likely water will remain within the system pipework which must also be removed.

### DRAIN THE AIR BLOWER

The next step in winterizing a Spa is to drain the air blower.

Begin by putting your Spa's cover on, and then plug the Spa back in and turn it on. Once the Spa is covered and turned on, activate the air blower function and let it run for about a minute to flush the water out of the channels. After draining the air blowers, safely turn off and unplug your Spa once again.

### LOOSEN UNIONS ON THE HEATER AND PUMPS

Open your Spa's access panel and locate the pumps and heater. Loosen the pump and heater unions to enable any remaining water to drain from the lines. Repeat this process on all pump unions if your Spa has more than one.

### REMOVE PUMP DRAIN PLUGS

Remove the lowest drain plug from the front of each pump. This allows any remaining water to drain from the inside of your Spa.

**USE WET VAC TO REMOVE WATER FROM THE LINES**

Remove water from the plumbing lines. Water left in the plumbing lines can freeze and cause serious damage to your Spa during winter. To clear out the lines, insert a wet vac into each drain, jet face, union, suction, and filter cavity. Place the wet-vac in each space for 10–15 seconds to ensure all water is sucked out.

**CLEAN SPA FILTER CARTRIDGES**

Winterizing your Spa is the perfect time to remove and clean any Spa filter cartridges. Leaving dirty filter cartridges in your spa over winter will lead to an unpleasant cleanup come springtime. Once you remove the cartridges, spray them down with a garden hose and use a filter cleaner to gently clean off any debris that builds up.

**REPLACE DRAIN PLUG ON PUMPS**

Once all the water is drained out of your Spa lines, replace the drain plug on the pump. Tighten all unions and ensure all gate valves are open.

**ADD SPA ANTIFREEZE**

The last step before putting the Spa cover on for the long winter is to pour one gallon of Spa/hot tub antifreeze into the top of each pump, and one gallon into the filter cavity. Antifreeze, as the name suggests, prevents any remaining water left in the lines from freezing. After pouring the antifreeze, place the equipment access panel back on if you haven't done so already.

**CLOSE THE SPA COVER**

And finally, after all your hard work winterizing your Spa, it's time to put the cover on, and start counting down the days until you can re-open it!

Winterizing your Spa may sound like a daunting process, but with these 10 easy steps, you'll have it done in no time. Alternatively contract a local Pool and Spa/Hot tub qualified technician who should be aware of the winterization process.

## **5.6. Accessory care**

**SIDING CARE**

Sidings can become dirty over time and wooden sidings can be dulled by the Sun's UV light or just weathered. Generally using a soapy water solution and gently jet washing, will bring the side paneling back to a fresh look. Wooden sides will at some point require an application of a staining oil (Oil for Thermally Modified Wood, Dark).

**SPA TOP COVERS**

Spa covers should be cleaned and air dried whenever possible. As per the spa sides, your cover can be cleaned with hot soapy water and gently jet washed clean. Spa Covers can become very heavy when they become wet, so care should be taken when lifting.

## 6. Troubleshooting

### Faults indicated via keypad (Balboa SpaTouch3 keypad)

<p><b>The water is too hot – M029*</b></p>	<p>The system has detected a spa water temp of about 43°C or more, and spa functions are disabled. System will auto reset when the spa water temp is below about 42°C. Check for extended pump operation or high ambient temp.</p>
<p><b>The water level is too low</b></p>	<p>This message can only appear on a system that uses a water level sensor. It appears whenever the water level gets too low (or the water level sensor is disconnected), and automatically disappears when the water level is adequate. Pumps and the heater turn OFF when this message appears.</p>
<p><b>The water flow is low – M016**</b></p>	<p>There may not be enough water flow through the heater to carry the heat away from the heating element. Heater startup will begin again after about 1 minute. See “Flow Related Checks” below.</p>
<p><b>The water flow has failed* – M017**</b></p>	<p>There is not enough water flow through the heater to carry the heat away from the heating element and the heater has been disabled. See “Flow Related Checks” below. After the problem has been resolved, reset the message*.</p>
<p><b>The heater may be dry* – M028**</b></p>	<p>Possible dry heater, or not enough water in the heater to start it. The spa is shut down for 15 minutes. Reset this message* to reset the heater start-up. See “Flow Related Checks” below.</p>
<p><b>The heater is dry* – M027**</b></p>	<p>There is not enough water in the heater to start it. The spa is shut down. After the problem has been resolved, you must reset the message* to restart heater start up. See “Flow Related Checks” below.</p>
<p><b>The heater is too hot* – M030**</b></p>	<p>One of the water temp sensors has detected about 48°C in the heater and the spa is shut down. You must reset the message* when water is below about 42°C. See “Flow Related Checks” below.</p>
<p><b>Flow-related checks</b></p>	<p>Check for low water level, suction flow restrictions, closed valves, trapped air, too many closed jets and pump prime. On some systems, even when spa is shut down by an error condition, some equipment may occasionally turn on to continue monitoring temperature or if freeze protection is needed.</p>

<b>Bubbles and gurgling noise</b>	Water level is low, and air is being sucked into the circulation system via the skimmer.
<b>Sensors are out of sync – M015**</b>	The temperature sensors may be out of sync by 3°F. Call for Service if this message does not disappear within a few minutes.
<b>Sensors are out of sync -- Call for service* – M026**</b>	The temperature sensors ARE out of sync. The fault above has been established for at least 1 hour. Call for Service.
<b>Sensor A Fault, Sensor B Fault – Sensor A: M031**, Sensor B: M032**</b>	A temperature sensor or sensor circuit has failed. Call for Service.
<b>Program memory failure* – M022**</b>	At Power-Up, the system has failed the Program Checksum Test. This indicates a problem with the firmware (operation program) and requires a service call.
<b>The settings have been reset (Persistent Memory Error) * – M021**</b>	Contact Aquatica or service organization if this message appears on more than one power-up.
<b>The clock has failed* – M020**</b>	Contact Aquatica or service organization.
<b>Configuration error</b>	The spa will not Start Up. Contact Aquatica or service organization.
<b>The GFCI test failed (System Could Not Test the GFCI) – M036**</b>	(North America Only) May indicate an unsafe installation. Contact Aquatica or service organization.
<b>Hot fault – M035**</b>	Water may be overheated. POWER DOWN THE SPA. DO NOT ENTER THE WATER. Contact your dealer or service organization.
<b>A pump may be stuck on – M034**</b>	A Pump Appears to have been Stuck ON when spa was last powered POWER DOWN THE SPA. DO NOT ENTER THE WATER. Contact your dealer or service organization.
<b>Check the pH</b>	May appear on a regular schedule, i.e. every 7 days. Check pH with a test kit and adjust pH with the appropriate chemicals.
<b>Check the sanitizer</b>	May appear on a regular schedule, i.e. every 7 days. Check sanitizer level and other water chemistry with a test kit and adjust with the appropriate chemicals.
<b>Check ozone</b>	May appear on a regular schedule. Change the UV as instructed by the manufacturer.

**Faults indicated via keypad (Gecko in.k1000)**

Please contact customer service and provide the error code below for further information.

<b>Code</b>	<b>Message</b>
<b>HL</b>	High Limit circuit has tripped!
<b>FLO - L01 FLO - L02 FLO</b>	FLO condition - Check filter, pump, blockage, air lock and water level
<b>NO FLO</b>	Persistent NO FLO, all off - Check filter, pump, blockage, air lock and water level
<b>HR</b>	A hardware error was detected (Relay stuck)
<b>OH</b>	Spa temperature is too high
<b>Pr</b>	Temp probes or detection circuit are defective
<b>AOH</b>	Elevated internal temperature
<b>FLC</b>	The pressure switch is closed
<b>SP in</b>	Input voltage issue
<b>RH NC</b>	Comm. error between in.xm2 - in.therm
<b>RH ID</b>	in.xm2 and in.therm incompatible
<b>SC ER</b>	Error detected during the learning mode
<b>F1</b>	in.xm2 Fuse # 1 is blown
<b>F2</b>	F2 in.xm2 Fuse # 2 is blown
<b>F3</b>	F3 in.xm2 Fuse # 3 is blown
<b>ER1</b>	ER1 SwimSpa config. : slave unit is missing
<b>Hr</b>	Hr Hardware error was detected (Thermal fuse)
<b>UPL</b>	The spa pack does not have valid software. Please insert valid in.stick to reprogram spa pack.
<b>CFLO</b>	No Flow condition
<b>HIBr</b>	Add fresh water to the spa
<b>HiBr</b>	Add fresh water to the spa
<b>LoBr</b>	Add BromiCharge to spa water
<b>NoBr</b>	Add BromiCharge to spa water
<b>Comm</b>	Verify cable connections
<b>Supp</b>	Connect power cord to 220 V source

## 7. Useful Information

### CONTACT INFORMATION

For any inquiries, please find our Aquatica contact details below:

- **Sales:** sales@aquaticabath.co.uk
- **Order Status:** customerservice@aquaticabath.co.uk
- **Shipping:** customerservice@aquaticabath.co.uk
- **Customer Service:** customerservice@aquaticabath.co.uk
- **Service and Warranty:** customerservice@aquaticabath.co.uk
- **General Queries:** info@aquaticabath.co.uk

Feel free to reach out via email, and one of our agents will respond within 72 hours (Monday to Friday). We are here to ensure your experience with us is seamless and satisfactory.

### PRODUCT INFORMATION

For further product details and documentation, please visit our website. You can find individual product pages as well as resources within the Customer Guides menu. While the information provided on the website is accurate at the time of publication, Aquatica reserves the right to change or improve its products without prior notice.

aquatica®

SPA Manual  
V1-24

**Blank**